

**New Generation of Secondary Standards Hermetically Sealed Construction Ultra High Precision Z-Foil Technology Resistors with TCR of  $\pm 0.2 \text{ ppm}/^\circ\text{C}$ , Tolerance of  $\pm 0.001 \%$  and Load Life Stability of  $\pm 0.002 \%$  (Metrology, Laboratory, Instrumentation, Industrial)**

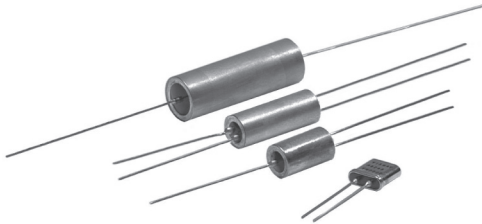

**INTRODUCTION**

The Z-Foil based oil filled, hermetically sealed HZ Series resistors represent an industry breakthrough. The hermetic sealing eliminates the ingress of moisture and oxygen, while the oil acts as a thermal conductor, thus eliminating long-term degradation elements of unsealed resistors, while at the same time allowing the device to accept short periods of overload without degradation.

The Z-Foil technology provides a significant reduction of the resistive components, sensitivity to ambient temperature variations (TCR) and applied power changes (PCR). When combined with the hermetic sealing and oil filling, the HZ Series resistors become **the most precise and stable resistors available**. They are used as the most precise secondary standards for ultra precision metrology.

With accuracies of  $\pm 0.001 \%$  (10 ppm) and a resistance range from  $5 \Omega$  to  $1.1 \text{ M}\Omega$  and long term shelf life of less than 2 ppm, these devices are virtually secondary standards that can be carried in sets for daily or periodic calibration of factory measurement equipment.

**The HZ Series is available with laboratory and metrology level precision and long-term stability with additional in-house oriented processes such as: chip stabilization, special TCR plotting, additional treatments for ultra stability and special post manufacturing operations (PMO). (Please refer to the last page)**

**TABLE 1 - TCR VS. RESISTANCE VALUE**

RESISTANCE VALUE ( $\Omega$ )	TYPICAL TCR AND MAX. SPREAD (- 55 °C to + 125 °C, + 25 °C ref.) (ppm/°C)
100 to < 1M1	$\pm 0.2 \pm 2$
50 to < 100	$\pm 0.2 \pm 3$
5 to < 50	$\pm 0.2 \pm 4$

**Note**

- For maximum TCR < 1 ppm/°C, see VHP100 and contact application engineering

**FEATURES**

- **Temperature coefficient of resistance (TCR):**  $\pm 0.2 \text{ ppm}/^\circ\text{C}$  typical (- 55 °C to + 125 °C, + 25 °C ref.). For ultra high performances (instrumentation and metrology) please refer to the last page
- Resistance range:  $5 \Omega$  to  $1.1 \text{ M}\Omega$  (higher or lower values of resistance available)
- Foil resistors are not restricted to standard values; specific “as required” values can be supplied at no extra cost or delivery (e.g. 1K2345 vs. 1K)
- **Power coefficient “ $\Delta R$  due to self heating”:** 5 ppm at rated power with the Z-Foil technology
- **Tolerance:** to  $\pm 0.001 \%$  (10 ppm)
- Load life stability to  $\pm 0.002 \%$  (20 ppm) at 25 °C, 2000 h at rated power
- **Load life stability, can be considerably improved through in-house stabilization**
- **Shelf life stability: 2 ppm for at least 6 years (unaffected by humidity)**
- Electrostatic discharge (ESD) up to 25 000 V
- Power rating: 0.3 W to 2.5 W at + 25 °C (depending on model - see table 2)
- Non-inductive, non-capacitive design
- Non hot spot design
- Rise time: 1 ns effectively no ringing
- Current noise:  $0.010 \mu\text{V}_{\text{RMS}}/\text{V}$  of applied voltage (< - 40 dB)
- Thermal EMF:  $0.05 \mu\text{V}/^\circ\text{C}$  typical
- Voltage coefficient: < 0.1 ppm/V
- Thermal stabilization time < 1 s (nominal value achieved within 10 ppm of steady state value)
- Non-inductive: < 0.08  $\mu\text{H}$
- Terminal finish available: lead (Pb)-free or tin/lead alloy
- Impervious to harmful environments - oil filled
- Prototype quantities available in just 5 working days or sooner. For more information, please contact [foil@vishaypg.com](mailto:foil@vishaypg.com)
- For better performances (values, TCR, tolerance, stability), please contact us



**FIGURE 1 - SHELF LIFE - VHA518-11 12K9 VS. QHE**

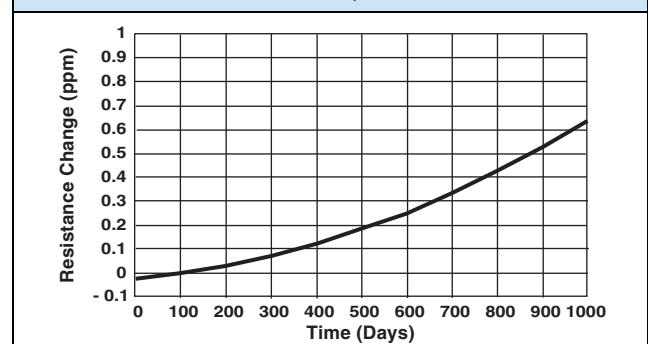

**FIGURE 2 - TRIMMING TO VALUES** (Conceptual Illustration)

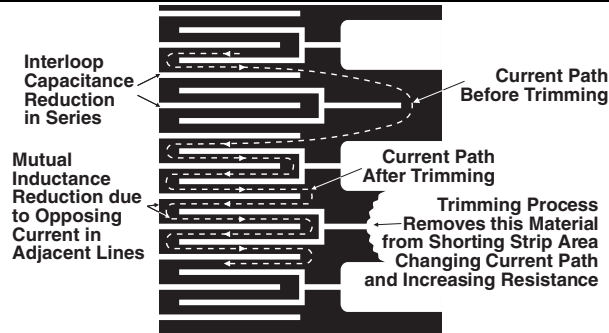

Note: Foil shown in black, etched spaces in white

**TABLE 2 - MODEL SELECTION**

MODEL NUMBER	RESISTANCE RANGE (Ω)	STANDARD RESISTANCE TOLERANCE PER RANGE		MAXIMUM WORKING VOLTAGE <sup>(2)</sup>	POWER RATING at +25 °C	AVERAGE WEIGHT (g)	CONSTRUCTION BRIEF	DIMENSIONS <sup>(3)</sup>															
		RANGE (Ω)	TIGHTEST (%)					INCHES	mm														
VHP202Z	10 to 66K 66K to 100K	1K to □ <sup>(1)</sup> 500 to < 1K 50 to < 500 30 to < 50 20 to < 30 10 to < 20 5 to < 10	± 0.001 ± 0.0025 ± 0.005 ± 0.01 ± 0.02 ± 0.05 ± 0.1	300	0.3 W 0.2 W	1.4	Oil-filled, tinned copper leads, nickel shell, kovar and glass header	W: 0.162 ± 0.020	4.11 ± 0.51														
VHA412Z	10 to 66K 66K to 100K							250	0.3 W 0.2 W	4.6	L: 0.625 ± 0.031 D: 0.375 ± 0.031 LL: 1.000 min.	15.88 ± 0.79 9.53 ± 0.79 25.4 min.											
VHA414Z	5 to 120K > 120K to 200K							350	0.5 W 0.3 W	7.3	L: 1.000 ± 0.031 D: 0.375 ± 0.031 LL: 1.000 min.	25.4 ± 0.79 9.53 ± 0.79 25.4 min.											
VHA512Z*	5 to 180K 180K to 300K			600	1.75 W 0.8 W 2.0 W 0.9 W 2.25 W 1.0 W 2.5 W 1.1 W 2.5 W 1.2 W	500	1.0 W 0.5 W 1.25 W 0.6 W 1.5 W 0.7 W	9.2	Oil-filled, tinned copper leads, tinned brass shell, kovar and glass end bells	L: 0.625 ± 0.031	15.88 ± 0.79												
VHA516-4Z*	5 to 240K > 240K to 400K									500	1.0 W 0.5 W 1.25 W 0.6 W 1.5 W 0.7 W	500	1.0 W 0.5 W 1.25 W 0.6 W 1.5 W 0.7 W	9.2	Oil-filled, tinned copper leads, tinned brass shell, kovar and glass end bells	L: 1.000 ± 0.031	25.4 ± 0.79						
VHA516-5Z*	5 to 300K > 300K to 500K															500	1.0 W 0.5 W 1.25 W 0.6 W 1.5 W 0.7 W	500	1.0 W 0.5 W 1.25 W 0.6 W 1.5 W 0.7 W	9.2	Oil-filled, tinned copper leads, tinned brass shell, kovar and glass end bells	D: 0.500 ± 0.031	12.7 ± 0.79
VHA516-6Z*	5 to 360K > 360K to 600K																					500	1.0 W 0.5 W 1.25 W 0.6 W 1.5 W 0.7 W
VHA518-7Z*	5 to 420K > 420K to 700K									600	1.75 W 0.8 W 2.0 W 0.9 W 2.25 W 1.0 W 2.5 W 1.1 W 2.5 W 1.2 W	500	1.0 W 0.5 W 1.25 W 0.6 W 1.5 W 0.7 W	9.2	Oil-filled, tinned copper leads, tinned brass shell, kovar and glass end bells	L: 1.500 ± 0.031	38.1 ± 0.79						
VHA518-8Z*	5 to 480K > 480K to 800K															600	1.75 W 0.8 W 2.0 W 0.9 W 2.25 W 1.0 W 2.5 W 1.1 W 2.5 W 1.2 W	500	1.0 W 0.5 W 1.25 W 0.6 W 1.5 W 0.7 W	9.2	Oil-filled, tinned copper leads, tinned brass shell, kovar and glass end bells	D: 0.500 ± 0.031	12.7 ± 0.79
VHA518-9Z*	5 to 540K > 540K to 900K																					600	1.75 W 0.8 W 2.0 W 0.9 W 2.25 W 1.0 W 2.5 W 1.1 W 2.5 W 1.2 W
VHA518-10Z*	5 to 600K > 600K to 1.0M	600	1.75 W 0.8 W 2.0 W 0.9 W 2.25 W 1.0 W 2.5 W 1.1 W 2.5 W 1.2 W													500	1.0 W 0.5 W 1.25 W 0.6 W 1.5 W 0.7 W	9.2	Oil-filled, tinned copper leads, tinned brass shell, kovar and glass end bells	L: 1.500 ± 0.031	38.1 ± 0.79		
VHA518-11Z*	5 to 660K > 660K to 1.1M																			600	1.75 W 0.8 W 2.0 W 0.9 W 2.25 W 1.0 W 2.5 W 1.1 W 2.5 W 1.2 W	500	1.0 W 0.5 W 1.25 W 0.6 W 1.5 W 0.7 W
VHA518-11Z*	5 to 660K > 660K to 1.1M	600	1.75 W 0.8 W 2.0 W 0.9 W 2.25 W 1.0 W 2.5 W 1.1 W 2.5 W 1.2 W													500	1.0 W 0.5 W 1.25 W 0.6 W 1.5 W 0.7 W	9.2	Oil-filled, tinned copper leads, tinned brass shell, kovar and glass end bells				

Notes: \*Available in a 4-lead terminal \*\*0.375 H available - See next page for numbered footnotes

**FIGURE 3 - TYPICAL RESISTANCE/TEMPERATURE CURVE**

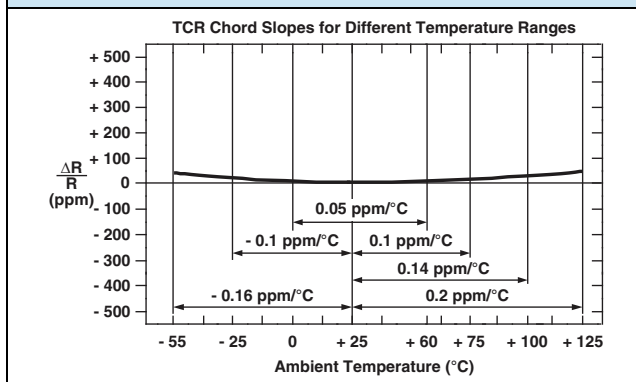

**FIGURE 4 - POWER DERATING CURVE**

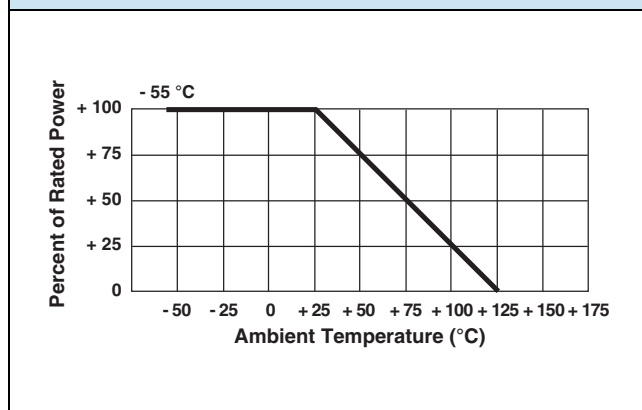

**FIGURE 5 - STANDARD IMPRINTING AND DIMENSIONS**

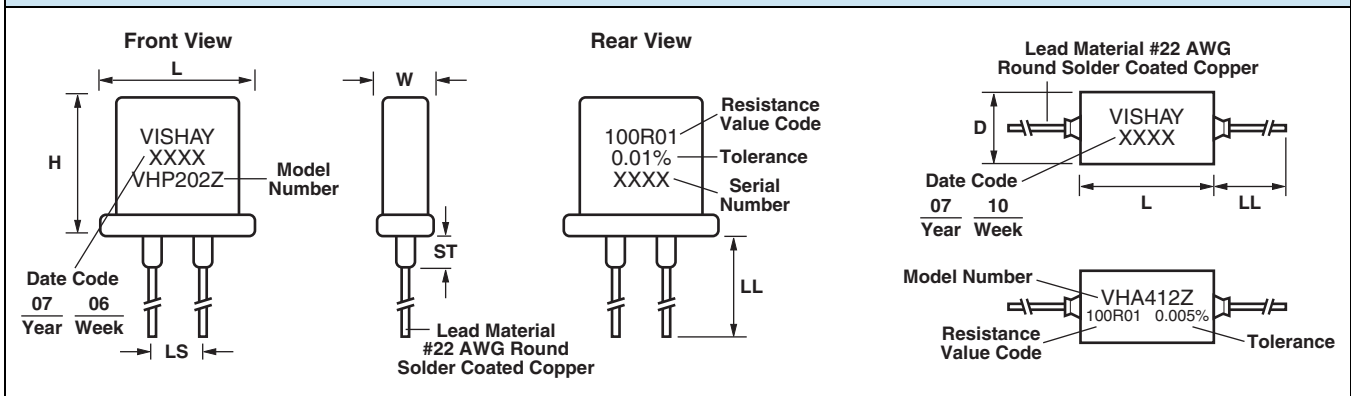

**TABLE 3 - "H" SERIES SPECIFICATIONS**

<b>Stability</b> <sup>(8)</sup>	
Load life at 2000 h	± 0.002 % (20 ppm) at 25 °C at rated power
Shelf life	± 2 ppm (0.0002 %) after at least 6 years
<b>Current Noise</b>	< 0.010 μV (RMS)/V of applied voltage (- 40 dB)
<b>High Frequency Operation</b>	
Rise time	1.0 ns without ringing
Inductance (L) <sup>(5)</sup>	0.1 μH maximum; 0.08 μH typical
Capacitance (C)	1.0 pF maximum; 0.5 pF typical
<b>Voltage Coefficient</b>	< 0.1 ppm/V <sup>(6)</sup>
<b>Thermal EMF</b> <sup>(7)</sup>	0.1 μV/°C maximum; 0.05 μV/°C typical; 1 μV/W maximum
<b>Hermeticity</b>	10 <sup>-7</sup> atmospheric cc/s maximum

**Notes**

- (1) Upper end of resistance range varies with model selected (i.e. VHP202Z; the range is to 100 kΩ; VHA518-10Z, the range is to 1.0 MΩ) per table 2
- (2) Not to exceed power rating of resistor
- (3) Insulating sleeve - a special case insulating plastic sleeve is available on VHAZ models - specify letter "P" as a suffix to model number (i.e. VHA412ZP)
- (4) 0.200" (5.08 mm) lead spacing available - specify VHP202ZJ
- (5) Inductance (L) due mainly to the leads
- (6) The resolution limit of existing test equipment (within measurement capability of the equipment, or "essentially zero")
- (7) μV/°C relates to EMF due to lead temperature difference and μV/W due to power applied to the resistor
- (8) Load life ΔR max. can be reduced through in-house oriented processes (PMO)

**POST MANUFACTURING OPERATIONS OR PMO FOR IMPROVED END OF LIFE**

Many analog applications can include requirements for performance under conditions of stress beyond the normal and over extended periods of time. This calls for more than just selecting a standard device and applying it to a circuit. The standard device may turn out to be all that is needed but an analysis of the projected service conditions should be made and it may well dictate a routine of stabilization known as post manufacturing operations or PMO. The PMO operations that will be discussed are only applicable to Bulk Metal<sup>®</sup> Foil resistors. They stabilize Bulk Metal Foil resistors while they are harmful to other types. Short time overload,

accelerated load life, and temperature cycling are the three PMO exercises that do the most to remove the anomalies down the road. Bulk Metal Foil resistors are inherently stable as manufactured. These PMO exercises are only of value on Bulk Metal Foil resistors and they improve the performance by amounts that are small but significant when compared to the very tight tolerances. Users are encouraged to contact Foil applications engineering for assistance in choosing the PMO operations that are right for their application.

**TABLE 4 - GLOBAL PART NUMBER INFORMATION (1)**

NEW GLOBAL PART NUMBER: Y1750120K500V9L (preferred part number format)

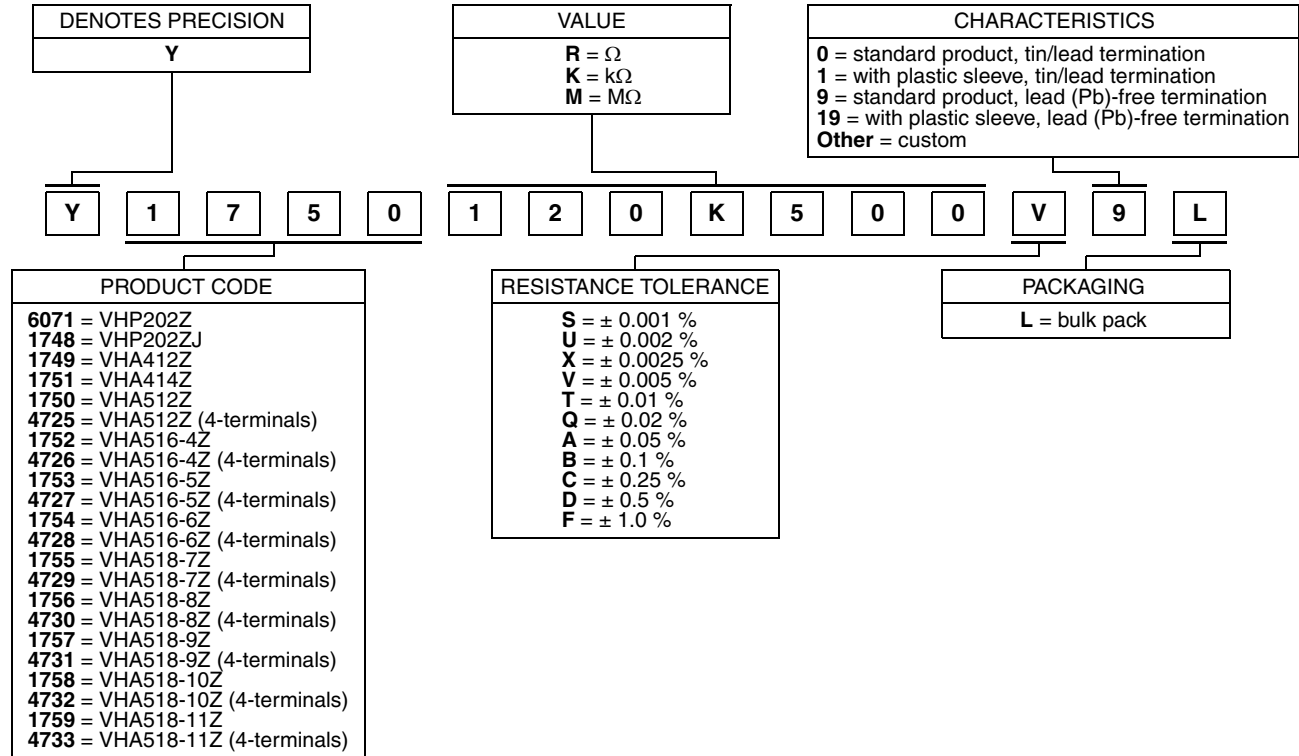

FOR EXAMPLE: ABOVE GLOBAL ORDER Y1750 120K500 V 9 L:

TYPE: VHA512Z  
 VALUE: 120.5 kΩ  
 ABSOLUTE TOLERANCE: ± 0.005 %  
 TERMINATION: lead (Pb)-free  
 PACKAGING: bulk pack

HISTORICAL PART NUMBER: VHA512ZT 120K50 V B (will continue to be used)

<b>VHA512Z</b>	<b>T</b>		<b>120K50</b>	<b>V</b>	<b>B</b>
MODEL	TERMINATION	PLASTIC SLEEVE	OHMIC VALUE	TOLERANCE	PACKAGING
VHP202Z VHP202ZJ VHA412Z VHA414Z VHA512Z (2) VHA516-4Z (2) VHA516-5Z (2) VHA516-6Z (2) VHA518-7Z (2) VHA518-8Z (2) VHA518-9Z (2) VHA518-10Z (2) VHA518-11Z (2)	T = lead (Pb)-free None = tin/lead	P = plastic sleeve None = standard	120K50 = 120.5 kΩ	S = ± 0.001 % U = ± 0.002 % X = ± 0.0025 % V = ± 0.005 % T = ± 0.01 % Q = ± 0.02 % A = ± 0.05 % B = ± 0.1 % C = ± 0.25 % D = ± 0.5 % F = ± 1.0 %	B = bulk pack

**Notes**

- (1) For non-standard requests, please contact application engineering
- (2) 4-terminal construction of these types are available, please quote:

	2-Terminal	VHA512Z	VHA516-4Z	VHA516-5Z	VHA516-6Z	VHA518-7Z	VHA518-8Z	VHA518-9Z	VHA518-10Z	VHA518-11Z
	4-Terminal	302073Z	302074-4Z	302074-5Z	302074-6Z	302075-7Z	302075-8Z	302075-9Z	302075-10Z	302075-11Z

### ULTRA HIGH PRECISION HERMETICALLY SEALED RESISTORS

#### INTRODUCTION

The response of Vishay's hermetically sealed resistors under variable conditions and stresses can be made better by additional in-house oriented processes (PMO). Processes such as short time overload, accelerated load life and temperature cycling produce enhanced levels of accuracy, stability and speed, offering immediate answers to many resistor applications currently believed unsolvable, and opens entirely new areas of design where the use of resistors had not been considered.

#### APPLICATIONS INCLUDE

- Resistance standards
- Feedback devices for operational amplifiers
- Precision voltage dividers
- Meter multipliers
- Precision bridge resistors
- Decade voltage dividers

See table 5 for the improvement to expect in hermetically sealed parts when calling for in-house oriented processes (PMO).

**TABLE 5 - EXAMPLES OF NON-STANDARD REQUIREMENTS**

TYPE	VALUE	TOLERANCE		TCR		REMARKS
		ABSOLUTE	MATCH	ABSOLUTE	TRACKING	
VHA518-11 Set of 10 Resistors (+ 20 °C to + 30 °C)	1 Ω	0.1 %	0.005 %	0.5 ppm/°C	0.5 ppm/°C	with PMO
VHA518-7 4-Terminal (+ 20 °C to + 30 °C)	10 Ω	0.05 %	-	0.5 ppm/°C	-	with PMO
	100 Ω	0.01 %	-	0.5 ppm/°C	-	
	120 Ω	0.005 %	-	0.4 ppm/°C	-	
	1K	0.005 %	-	0.3 ppm/°C	-	
	10K	0.001 %	-	0.3 ppm/°C	-	
VHA518-7 4-Terminal Matched Pairs (+ 20 °C to + 30 °C)	10 Ω	0.05 %	0.02 %	0.5 ppm/°C	0.5 ppm/°C	with PMO
	100 Ω	0.01 %	0.01 %	0.5 ppm/°C	0.5 ppm/°C	
	1K	0.005 %	0.002 %	0.3 ppm/°C	0.3 ppm/°C	
	10K	0.001 %	0.002 %	0.3 ppm/°C	0.3 ppm/°C	
VHA518 Set of 10 Resistors (+ 18 °C to + 28 °C, + 23 °C ref.)	999Ω475	0.05 %	0.005 %	0.5 ppm/°C	0.5 ppm/°C	with PMO

#### ORDERING INFORMATION

Resistors are built to your requirements. Send your schematic and electrical requirements to the applications engineering department at [foil@vishaypg.com](mailto:foil@vishaypg.com). A unique part number will be assigned which defines all aspects of your resistor.

## Disclaimer

All product specifications and data are subject to change without notice.

Vishay Precision Group, Inc., its affiliates, agents, and employees, and all persons acting on its or their behalf (collectively, "Vishay Precision Group"), disclaim any and all liability for any errors, inaccuracies or incompleteness contained herein or in any other disclosure relating to any product.

Vishay Precision Group disclaims any and all liability arising out of the use or application of any product described herein or of any information provided herein to the maximum extent permitted by law. The product specifications do not expand or otherwise modify Vishay Precision Group's terms and conditions of purchase, including but not limited to the warranty expressed therein, which apply to these products.

No license, express or implied, by estoppel or otherwise, to any intellectual property rights is granted by this document or by any conduct of Vishay Precision Group.

The products shown herein are not designed for use in medical, life-saving, or life-sustaining applications unless otherwise expressly indicated. Customers using or selling Vishay Precision Group products not expressly indicated for use in such applications do so entirely at their own risk and agree to fully indemnify Vishay Precision Group for any damages arising or resulting from such use or sale. Please contact authorized Vishay Precision Group personnel to obtain written terms and conditions regarding products designed for such applications.

Product names and markings noted herein may be trademarks of their respective owners.